

Project:	Quantity:
Model #:	Approval:

For Commercial Use Only

Standard Range SR-CB48-M 48" Gas Countertop Radiant Charbroiler-140,000BTU



FEATURES

- “U” shape burners
- Adjustable pilot light lit from front of unit
- 35,000 BTU / burner
- Stainless steel cabinet
- Cool-to-the-touch” front s/s edge
- Adjustable stainless steel legs, non-skid feet
- 3/4” NPT rear gas connection
- Easy to remove full width crumb tray
- Includes gas regulator
- Natural Gas with LP Conversion Kit

- CSA
- cCSAus
- CSA Sanitation



USR Brands Group is a US supplier of premium quality commercial cooking, refrigeration and food preparation equipment. Our aim is simple. Produce industry-leading commercial restaurant equipment at reasonable prices, and back it all up with an easy to understand, no nonsense warranty that people can count on.

Project:	Quantity:
Model #:	Approval:

For Commercial Use Only

TECHNICAL DATA

DIMENSIONS

Exterior Dimensions	48"L x 30"D x 15.5"H
Packaging Dimensions	51.2"L x 33.5"D x 19.3"H
Unit Weight	198 lb.
Shipping Weight	229 lb.

COOKING

Numbers of Burners	4
Total BTU	140,000
Control Type	Maunal
Gas Inlet Size	3/4"
Power Type	NG / LP
Heating Source	Radiant

CONSTRUCTION

Exterior Material	Stainless Steel
Frame Structure	Welded
Number of Legs	4
Side Splash	Yes

TECHNICAL DRAWING

MODEL: SR-CB48-M

MFR MODEL:



Front View

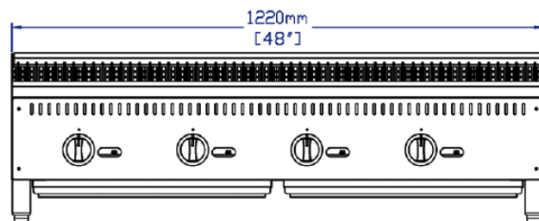

Side View

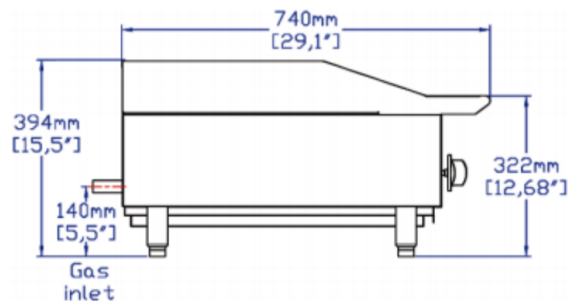

Top View

